











PLEASE MARK DESIRED LOCATION OF OPTIONS  
 SHOWN IN LEGEND ON FLOOR PLAN  
 HDW 101410

<u>DESCRIPTION</u>	<u>SYMBOL</u>	<u>DESIGNATION</u>
208V OUTLET =		= 
TYP. EMERGENCY FLOOD LIGHTS =		= E/L
120V DUPLEX OUTLET =		= 
LIGHT SWITCH =		= 
MAIN PANEL =		= 
TYP. 2' X 4' LAY IN 4 TUBE CLEANROOM LIGHT FIXTURE =		= L/F
TYP. 2' X 4' FAN POWERED HEPA FILTER =		= F/U



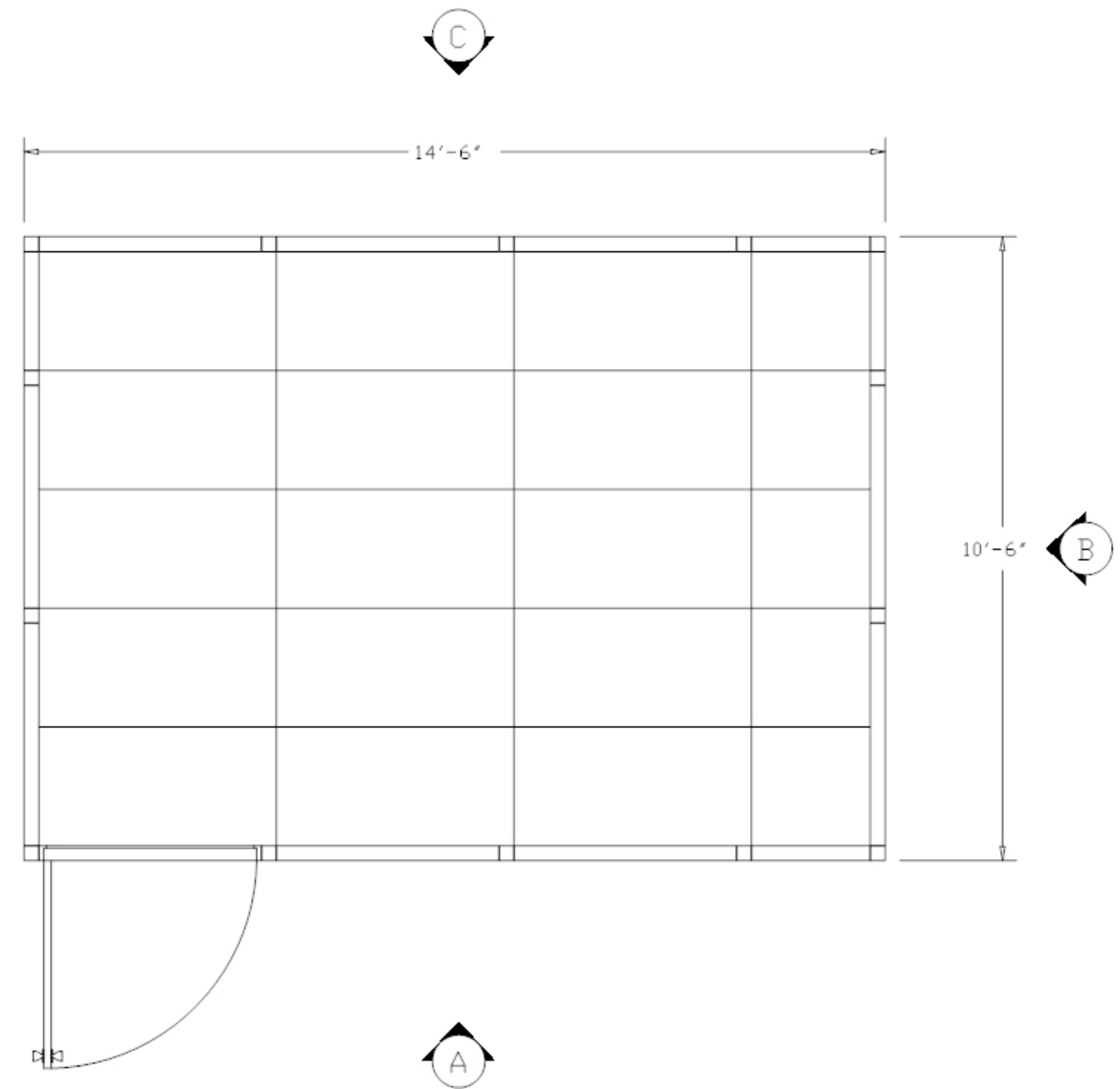
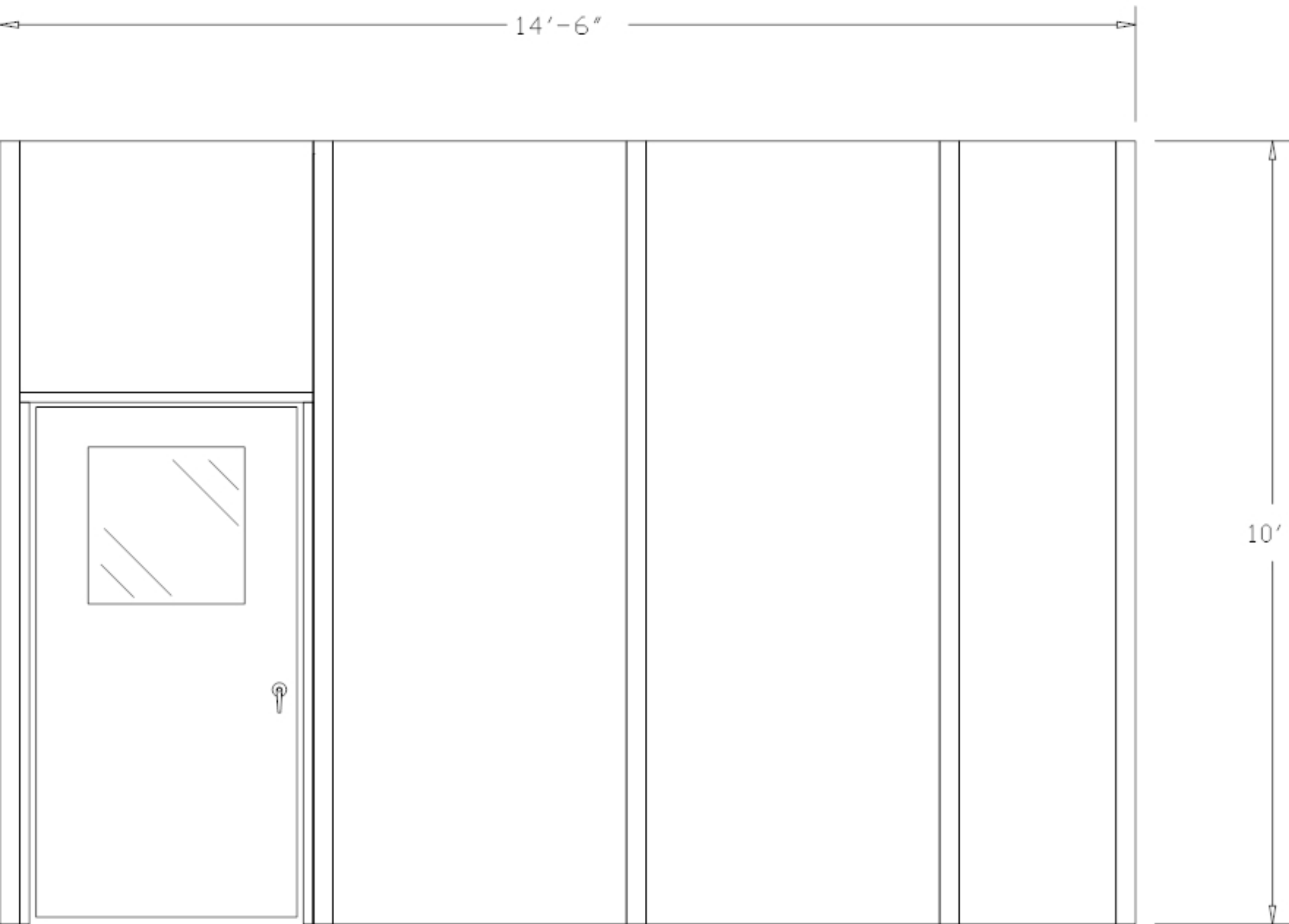

"A" ELEVATION

HDW 101410

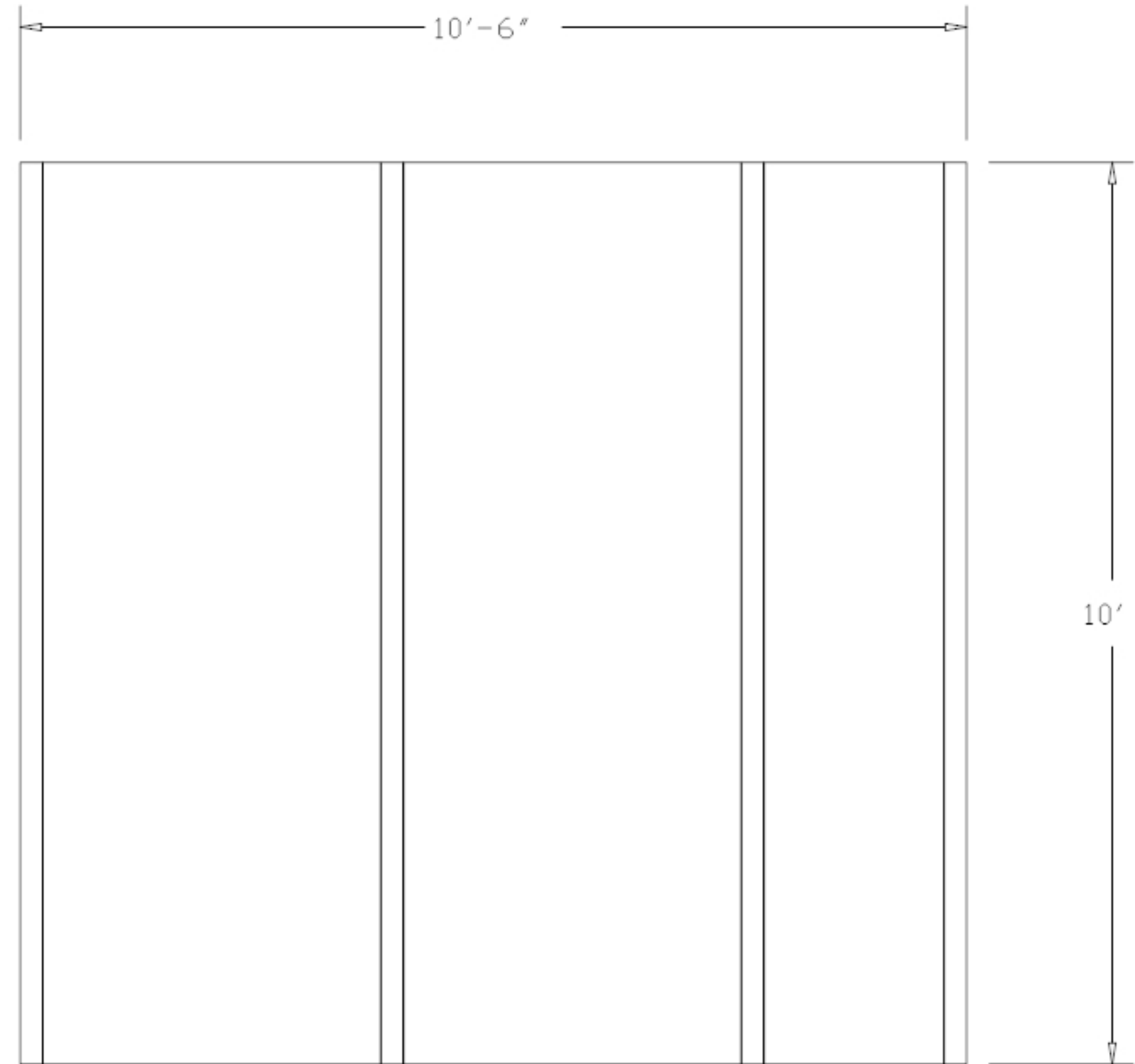

"B" ELEVATION

PLEASE MARK DESIRED LOCATION OF OPTIONS  
 SHOWN IN LEGEND ON FLOOR PLAN  
 HDW 101410

<u>DESCRIPTION</u>	<u>SYMBOL</u>	<u>DESIGNATION</u>
WINDOW PANEL		W/P
SOLID PANEL		S/P
42" X 80" DOOR W/ 2' X 2' WINDOW		D/L
DOUBLE DOOR W/ 2' X 2' WINDOW		DD/L

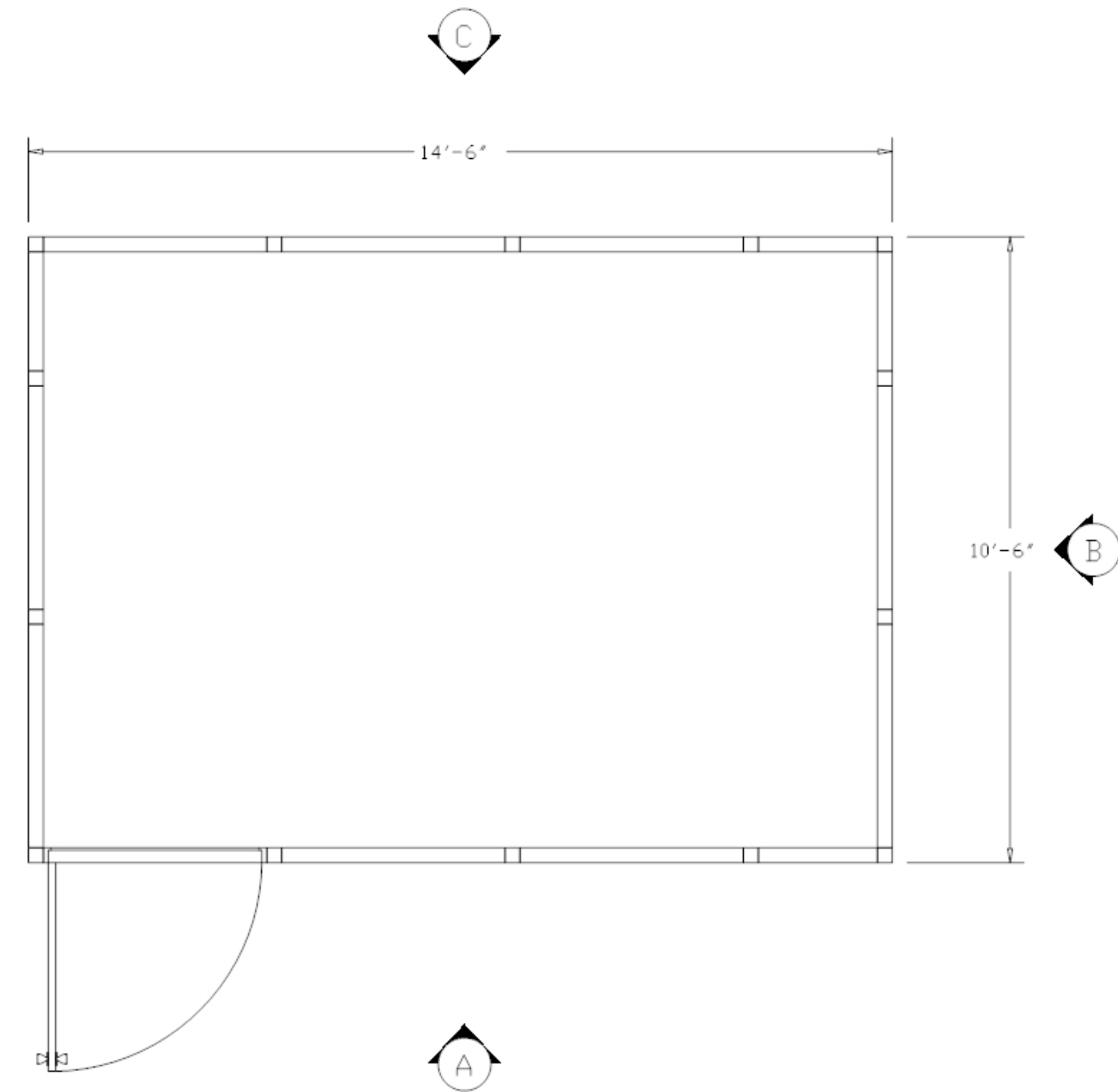

PLEASE MARK DESIRED LOCATION OF OPTIONS

SHOWN IN LEGEND ON FLOOR PLAN

HDW 101410

DESCRIPTION

SYMBOL

DESIGNATION

TYP. 2' X 4'  
LAY IN  
CEILING TILE

=



=

C/T

TYP. 2' X 4'  
LAY IN 4 TUBE  
CLEANROOM  
LIGHT FIXTURE

=



=

L/F

TYP. 2' X 4'  
FAN POWERED  
HEPA FILTER

=



=

F/U

