







PLEASE MARK DESIRED LOCATION OF OPTIONS
 SHOWN IN LEGEND ON FLOOR PLAN
 HDW 101810

| <u>DESCRIPTION</u> | <u>SYMBOL</u> | <u>DESIGNATION</u> |
|--|---|---|
| 208V OUTLET = |  |  |
| TYP. EMERGENCY FLOOD LIGHTS = |  | E/L |
| 120V DUPLEX OUTLET = |  |  |
| LIGHT SWITCH = | \$ | \$ |
| MAIN PANEL = |  |  |
| TYP. 2' X 4' LAY IN 4 TUBE CLEANROOM LIGHT FIXTURE = |  | L/F |
| TYP. 2' X 4' FAN POWERED HEPA FILTER = |  | F/U |





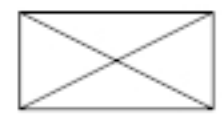
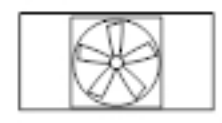
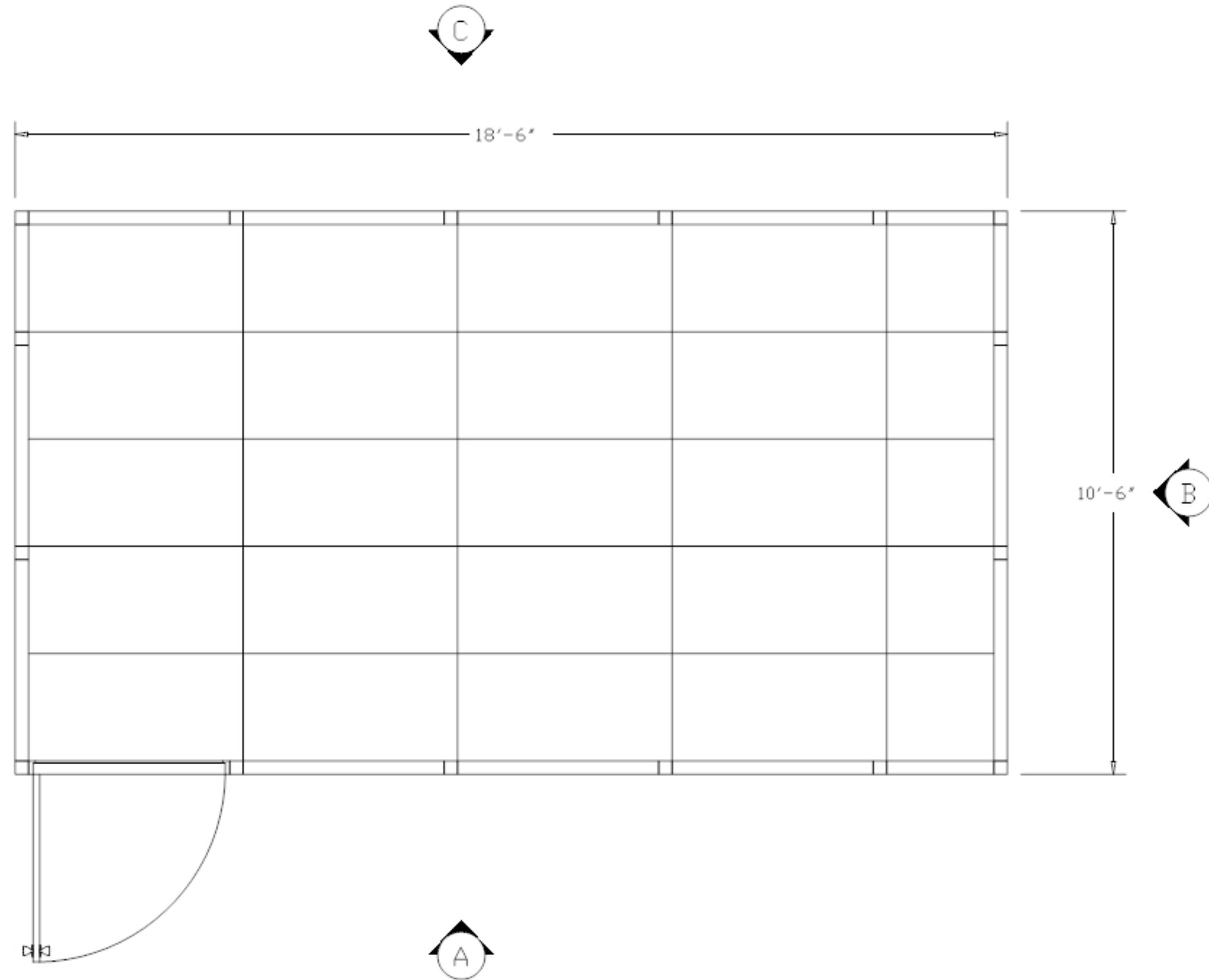
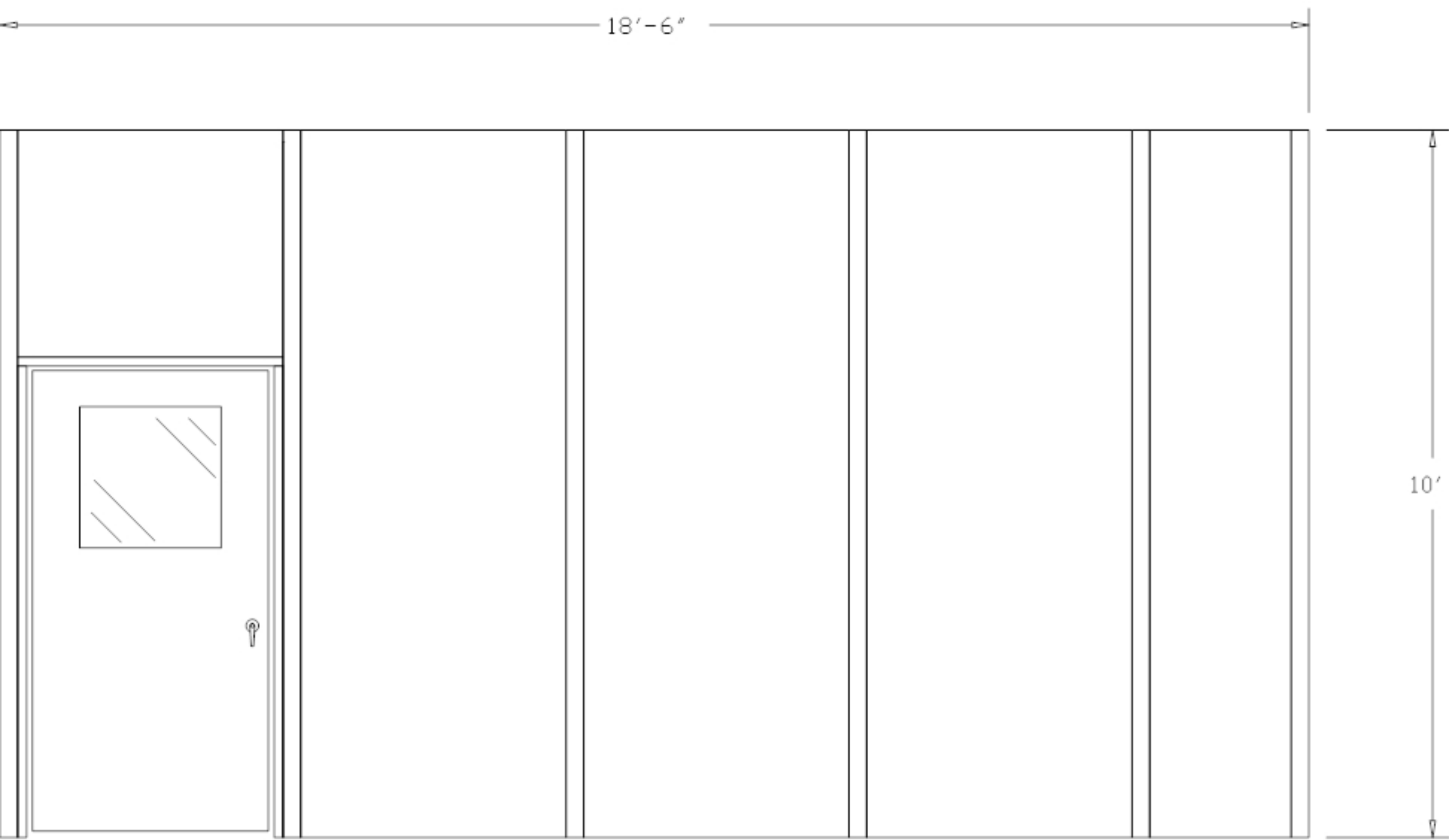

"A" ELEVATION

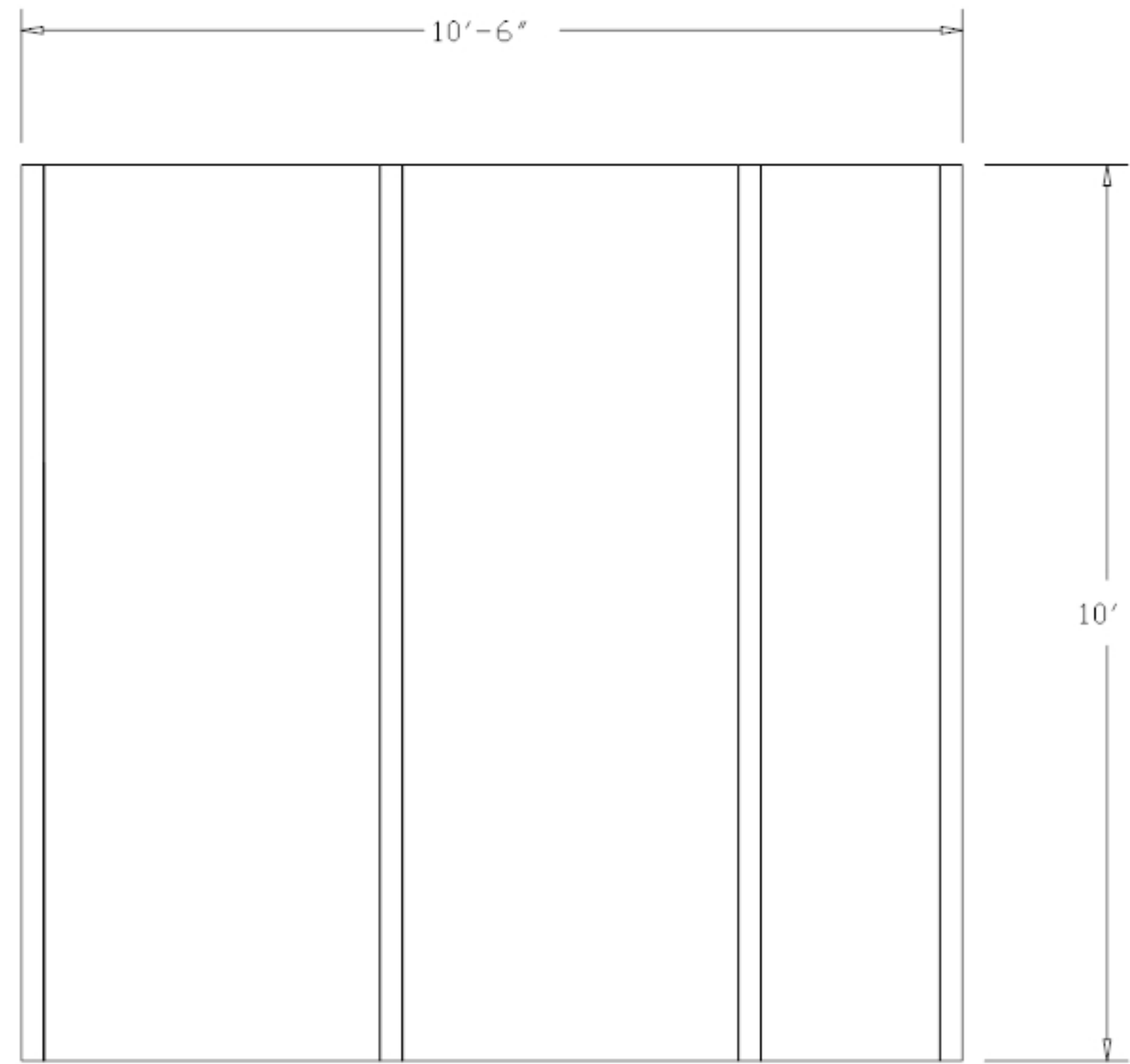
HDW 101810



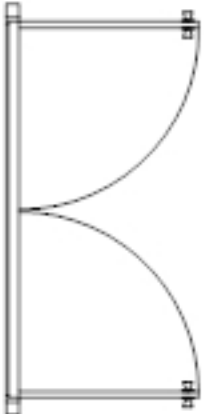

"B" ELEVATION

PLEASE MARK DESIRED LOCATION OF OPTIONS
 SHOWN IN LEGEND ON FLOOR PLAN
 HDW 101810

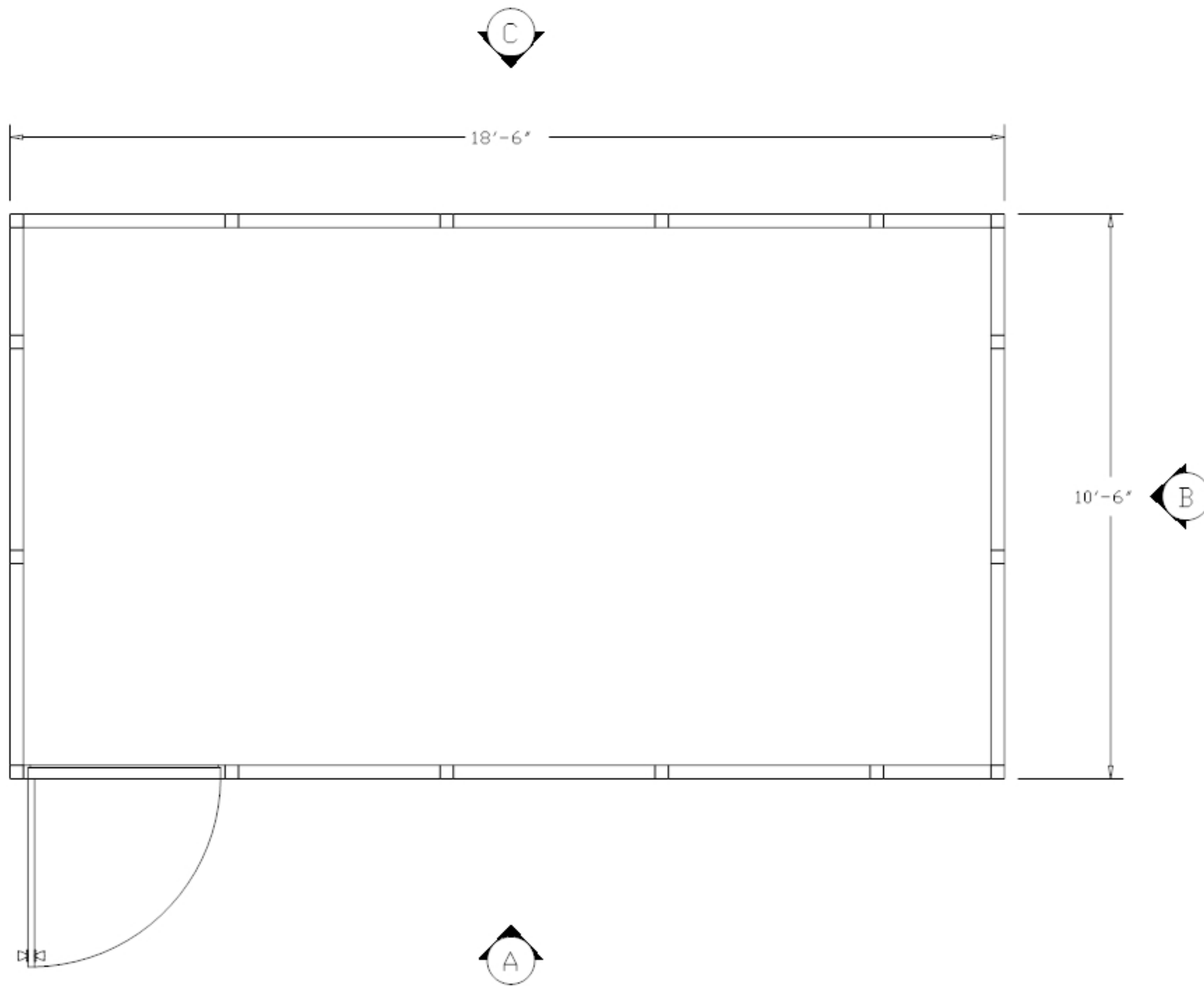
| <u>DESCRIPTION</u> | <u>SYMBOL</u> | <u>DESIGNATION</u> |
|--|---|--------------------|
| WINDOW PANEL |  | W/P |
| SOLID PANEL |  | S/P |
| 42" X 80" DOOR W/ 2' X 2' WINDOW |  | D/L |
| DOUBLE DOOR W/ 2' X 2' WINDOW |  | DD/L |



PLEASE MARK DESIRED LOCATION OF OPTIONS
 SHOWN IN LEGEND ON FLOOR PLAN
 HDW 101810

| <u>DESCRIPTION</u> | <u>SYMBOL</u> | <u>DESIGNATION</u> |
|---|---|--------------------|
| TYP. 2' X 4' LAY IN CEILING TILE |  | C/T |
| TYP. 2' X 4' LAY IN 4 TUBE CLEANROOM LIGHT FIXTURE |  | L/F |
| TYP. 2' X 4' FAN POWERED HEPA FILTER |  | F/U |

