



PLEASE MARK DESIRED LOCATION OF OPTIONS  
SHOWN IN LEGEND ON FLOOR PLAN  
SFW 12128

<u>DESCRIPTION</u>	<u>SYMBOL</u>	<u>DESIGNATION</u>
SOLID CURTAIN	=  =	S/C
STRIP DOOR	=  =	S/D





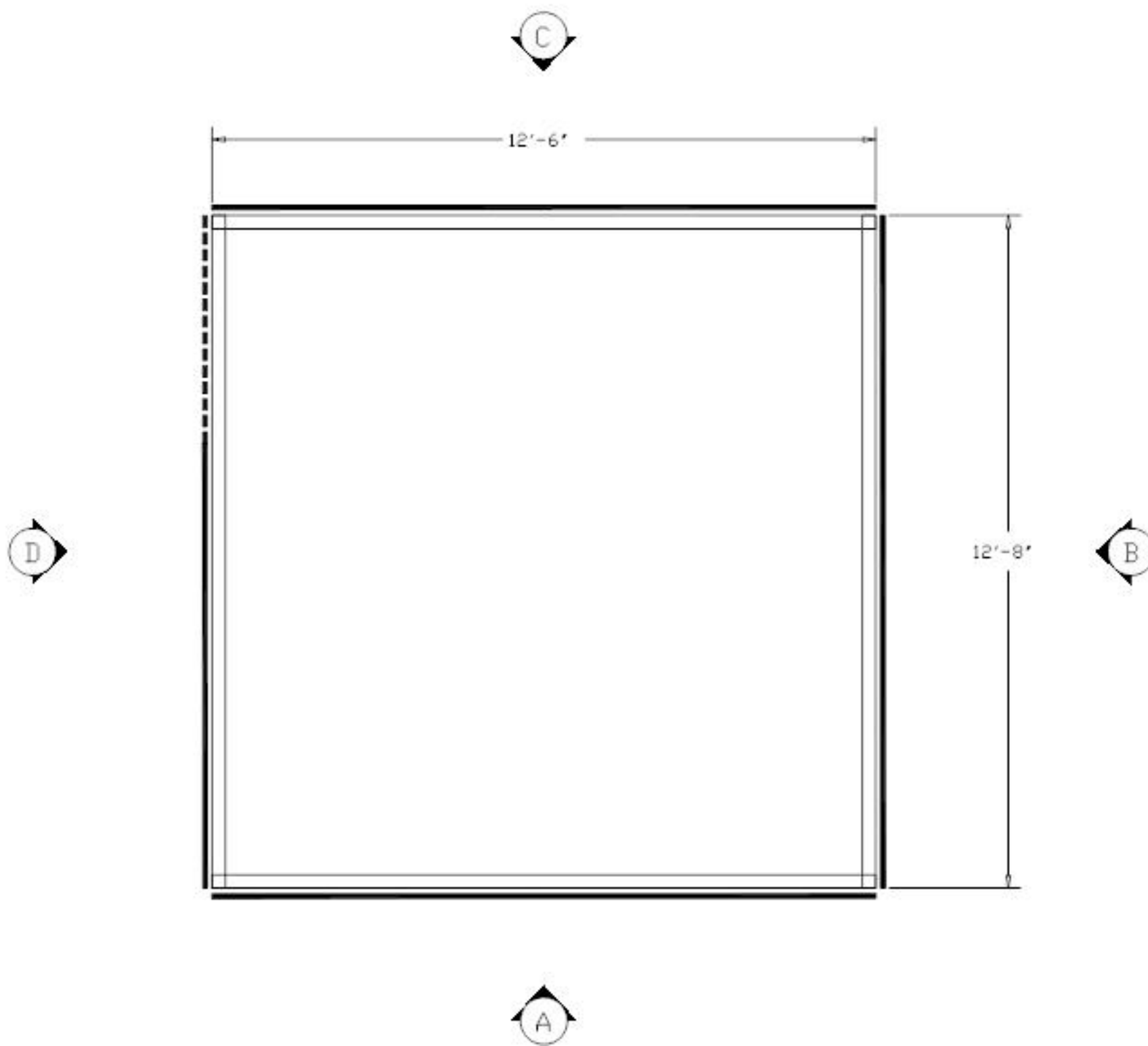
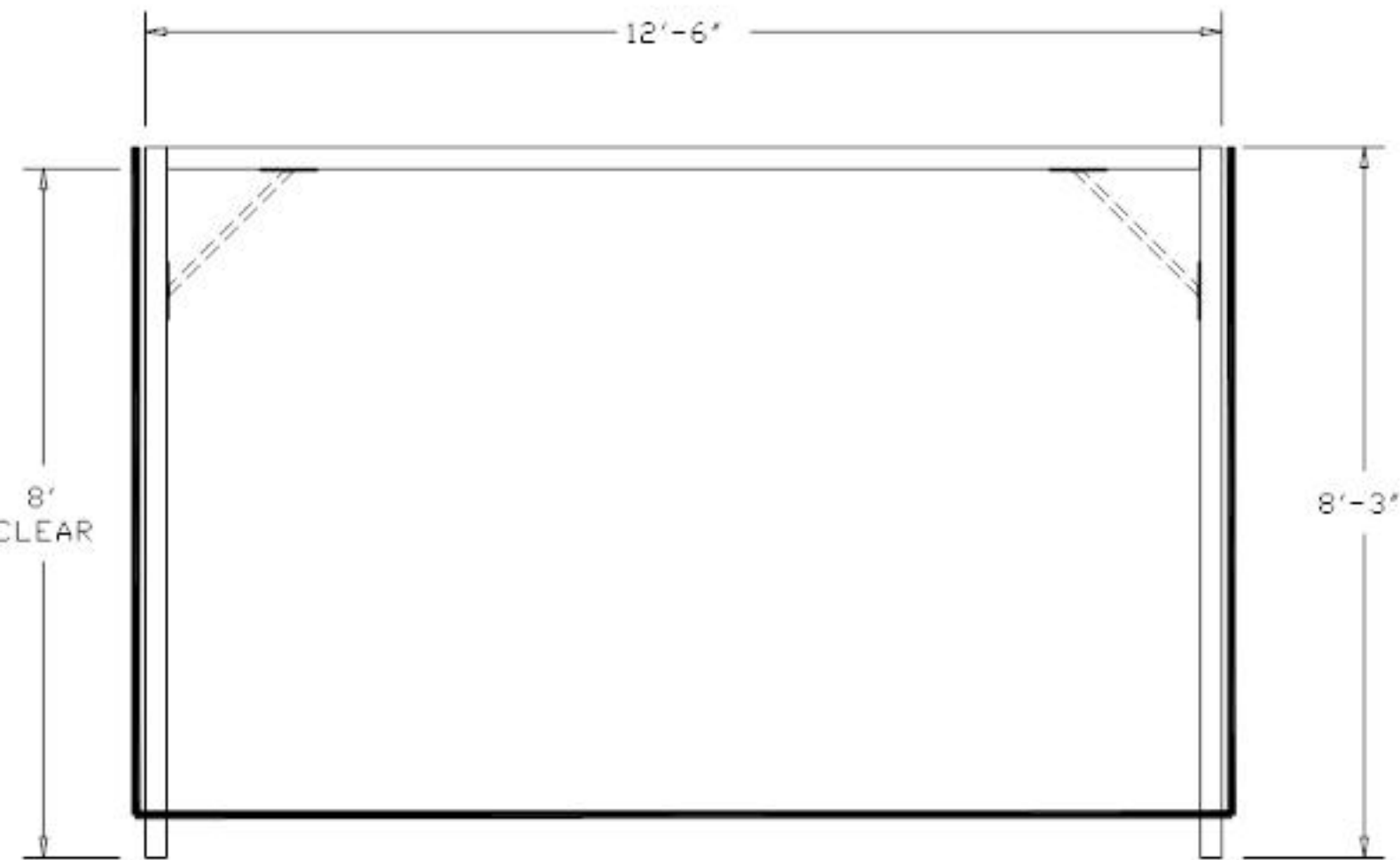

"A" ELEVATION

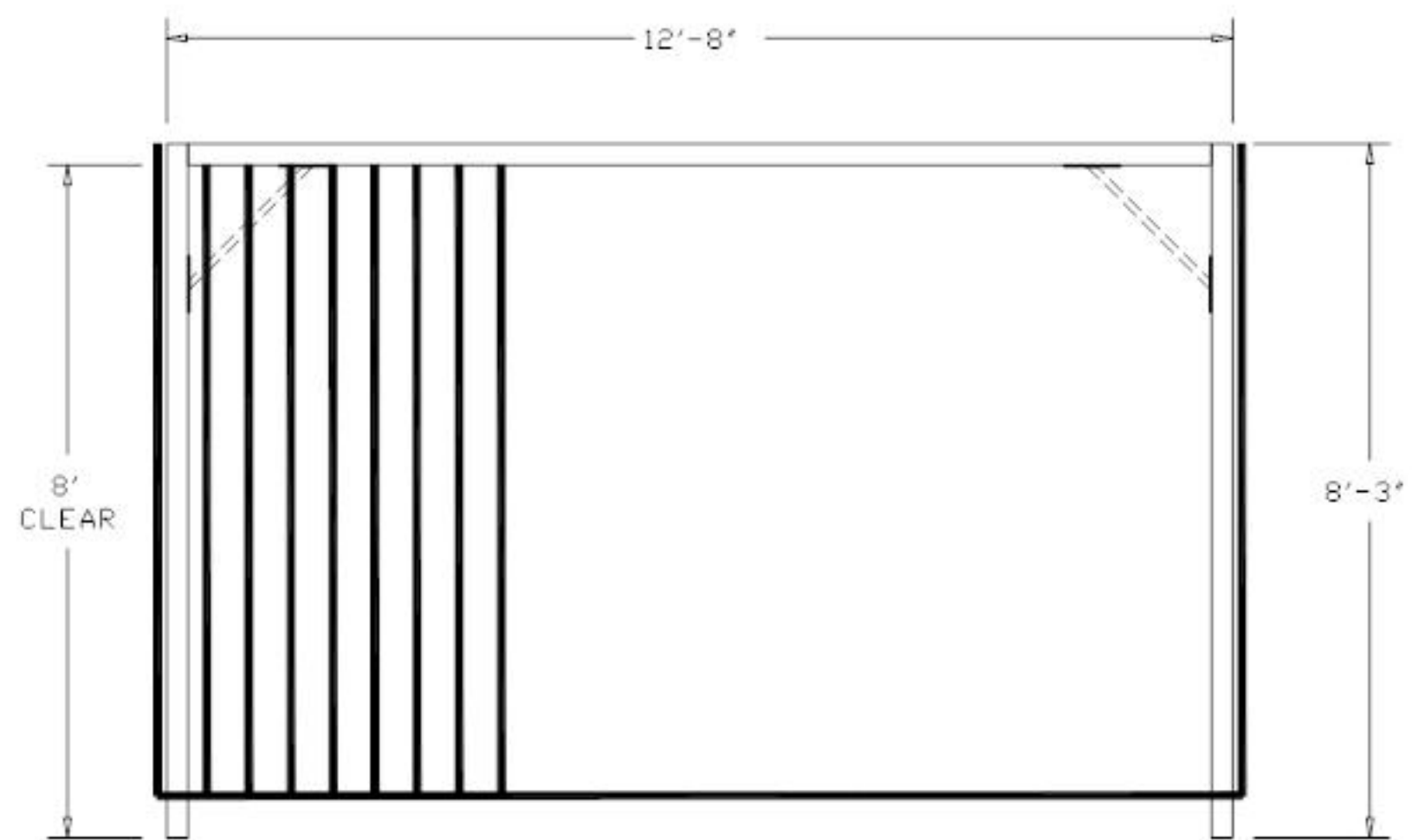
SFW 12128





"D" ELEVATION

PLEASE MARK DESIRED LOCATION OF OPTIONS  
 SHOWN IN LEGEND ON FLOOR PLAN  
 SFW 12128

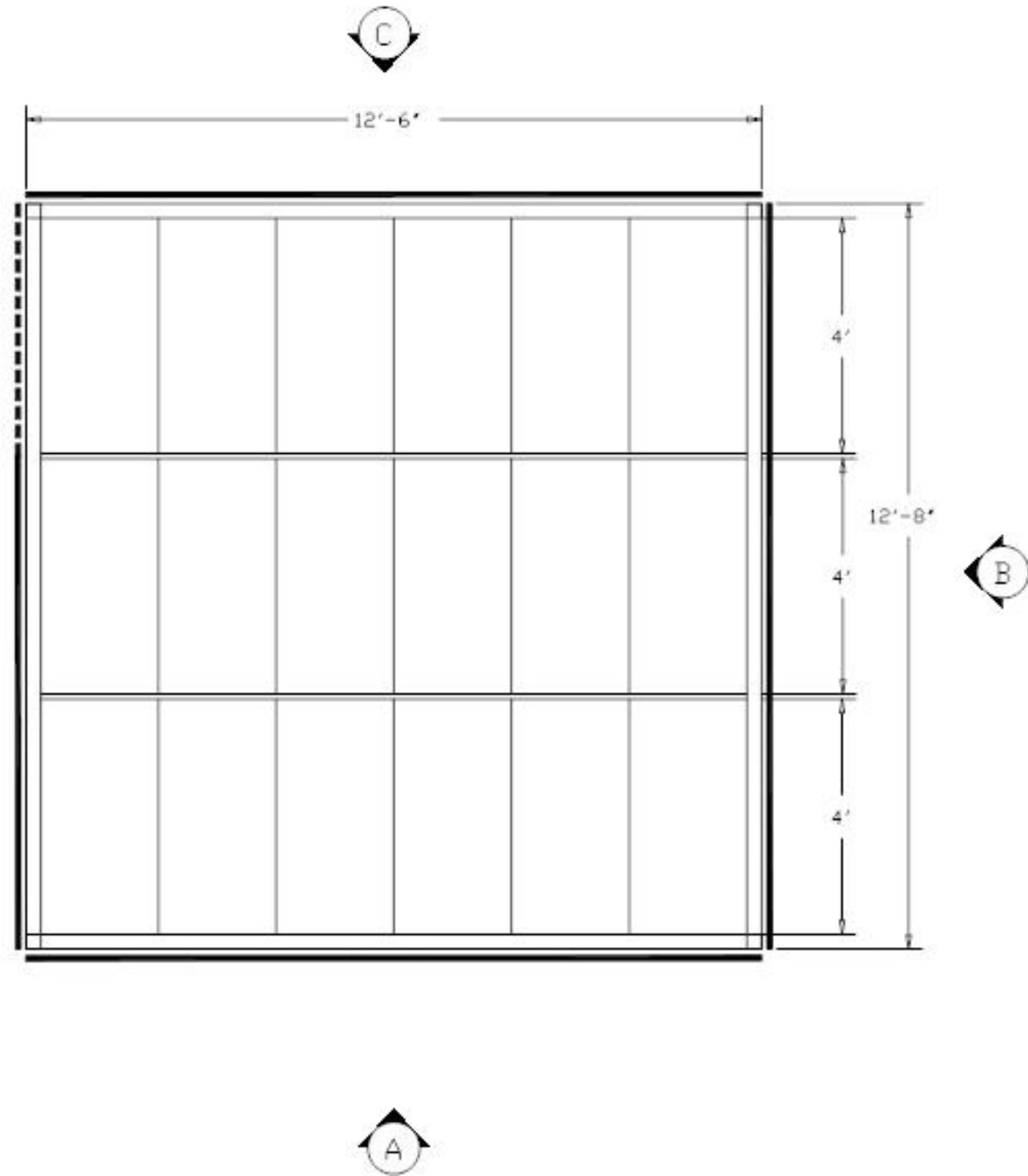
<u>DESCRIPTION</u>	<u>SYMBOL</u>	<u>DESIGNATION</u>
TYP. 2' X 4' LAY IN CEILING TILE	= 	= C/T
TYP. 2' X 4' LAY IN 4 TUBE CLEANROOM LIGHT FIXTURE	= 	= L/F
TYP. 2' X 4' FAN POWERED HEPA FILTER	= 	= F/U



PLEASE MARK DESIRED LOCATION OF OPTIONS  
 SHOWN IN LEGEND ON FLOOR PLAN  
 SFW 12128

<u>DESCRIPTION</u>	<u>SYMBOL</u>	<u>DESIGNATION</u>
120V DUPLEX OUTLET	⌀	⌀
LIGHT SWITCH	\$	\$
MAIN PANEL	PNL	PNL
TYP. 2' X 4' LAY IN 4 TUBE CLEANROOM LIGHT FIXTURE		L/F
TYP. 2' X 4' FAN POWERED HEPA FILTER		F/U

D

