

PLEASE MARK DESIRED LOCATION OF OPTIONS
 SHOWN IN LEGEND ON FLOOR PLAN
 EX3-10148

<u>DESCRIPTION</u>	<u>SYMBOL</u>	=	<u>DESIGNATION</u>
208V OUTLET =	⊕	=	⊕
TYP. EMERGENCY FLOOD LIGHTS =		=	E/L
120V DUPLEX OUTLET =	⊕	=	⊕
LIGHT SWITCH =	\$	=	\$
MAIN PANEL =	PNL	=	PNL
TYP. 2' X 4' LAY IN 4 TUBE LIGHT FIXTURE =		=	L/F
THRU WALL HVAC UNIT =	HVAC	=	HVAC

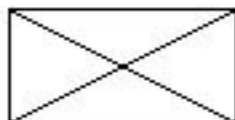

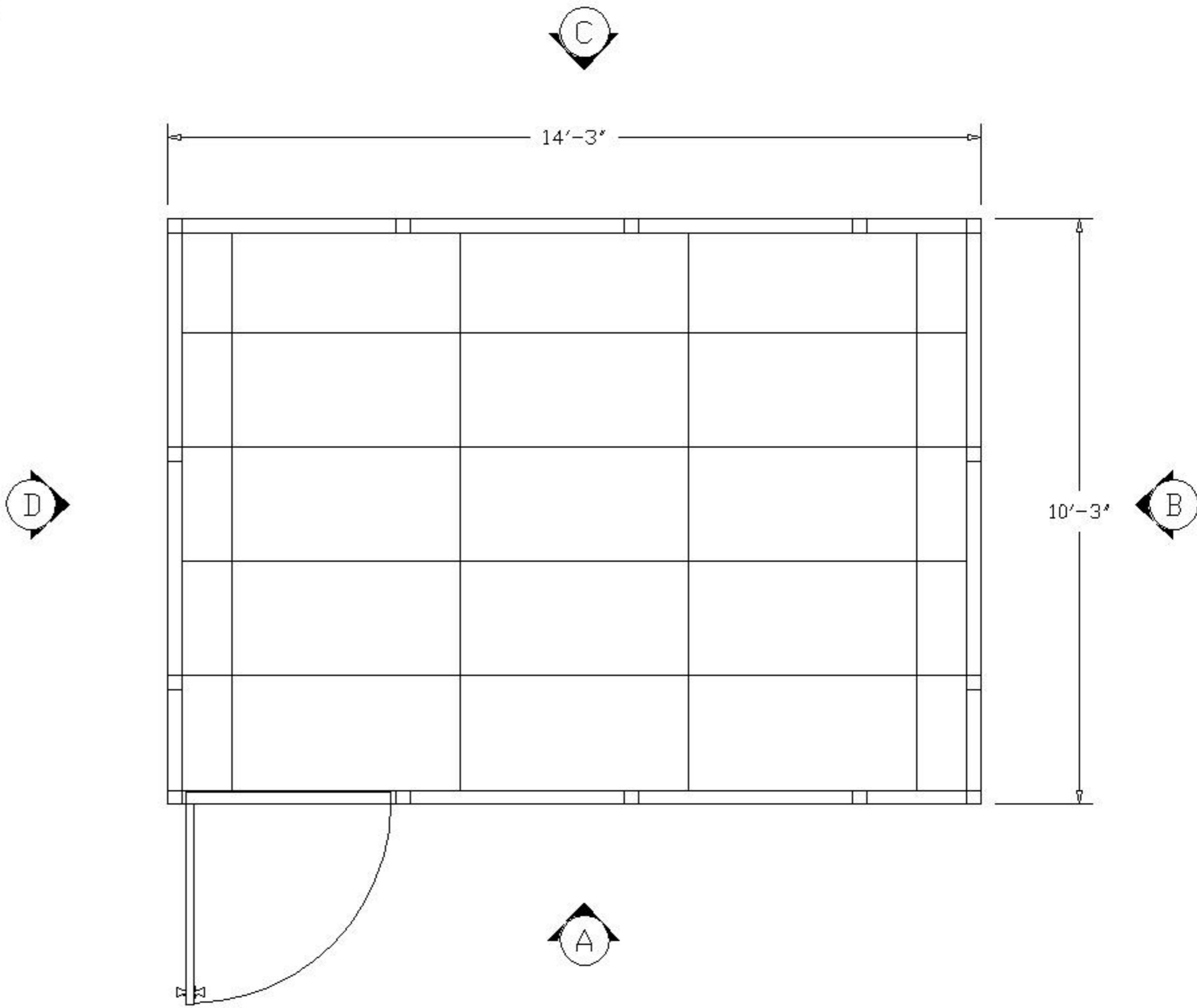
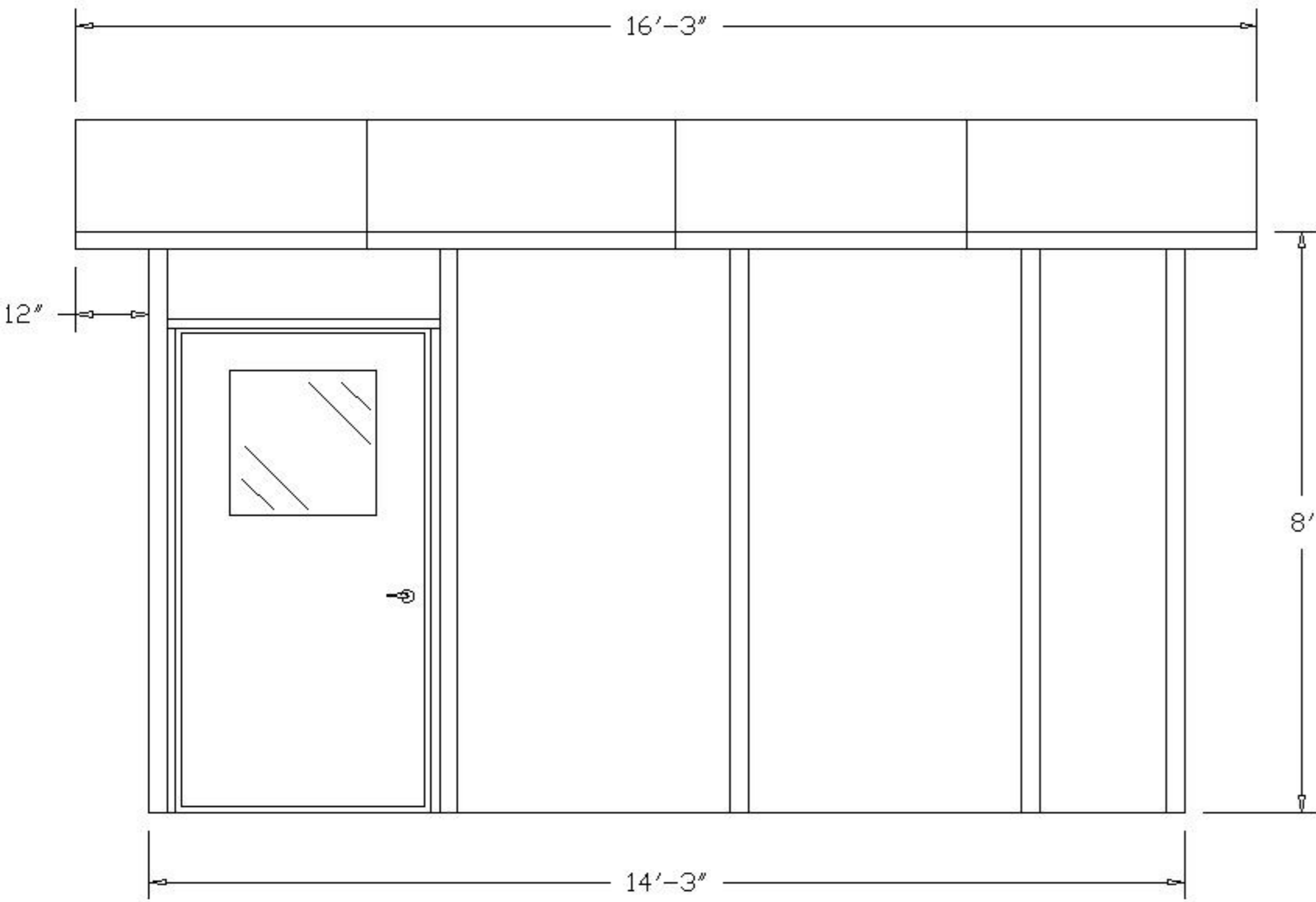

"A" ELEVATION

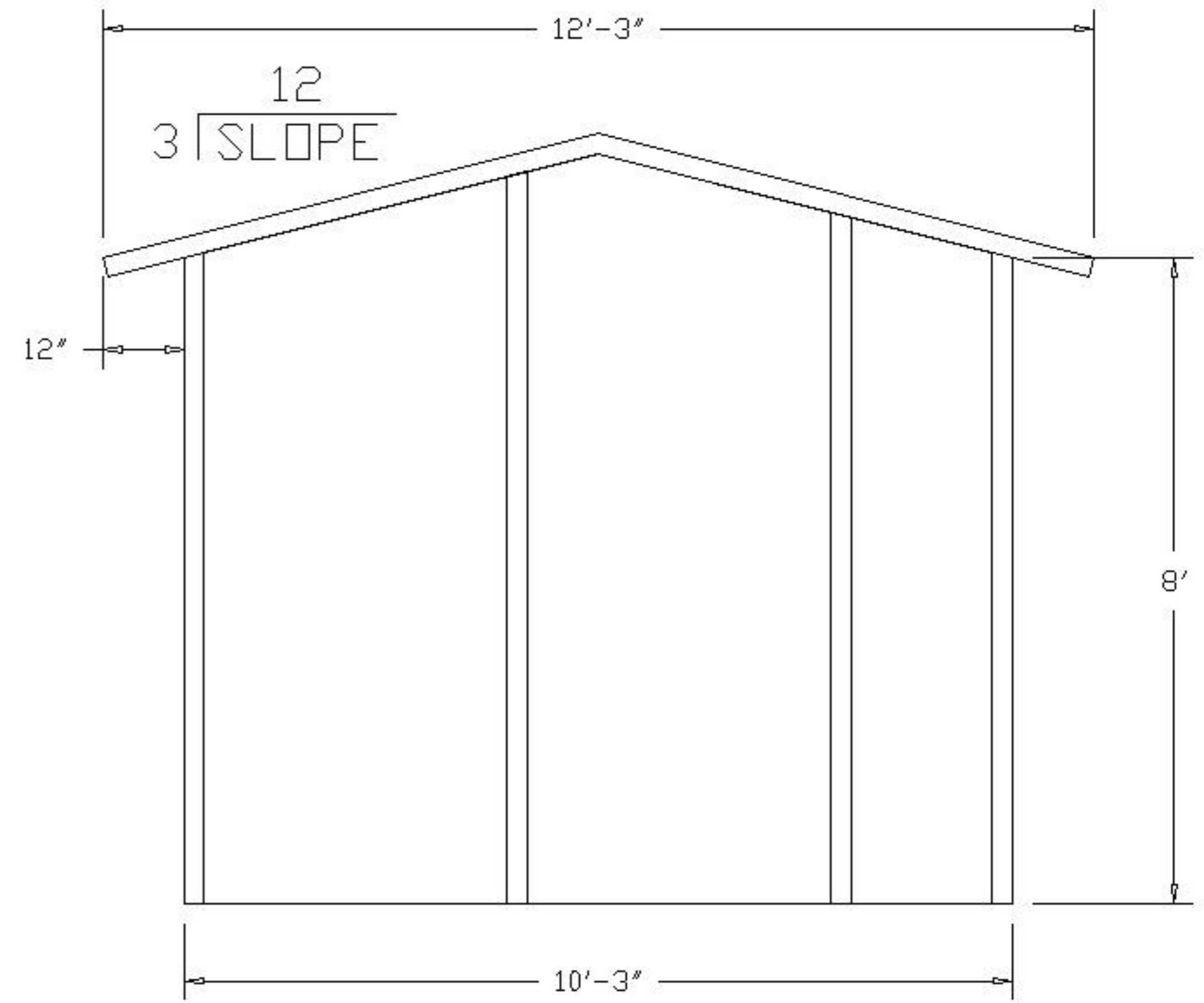

EX3-10148



"B" ELEVATION

PLEASE MARK DESIRED LOCATION OF OPTIONS
 SHOWN IN LEGEND ON FLOOR PLAN

EX3-10148

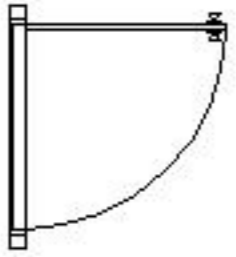
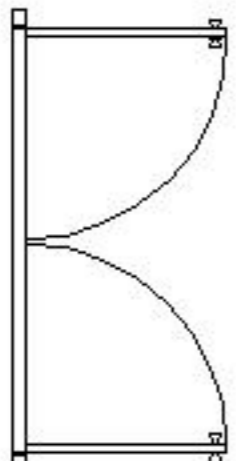
<u>DESCRIPTION</u>	<u>SYMBOL</u>	<u>DESIGNATION</u>
WINDOW PANEL =		W/P
SLIDING WINDOW PANEL =		SW/P
SOLID PANEL =		S/P
42" X 80" DOOR W/ 2' X 2' WINDOW =		D/L
DOUBLE DOOR W/ 2' X 2' WINDOW =		DD/L

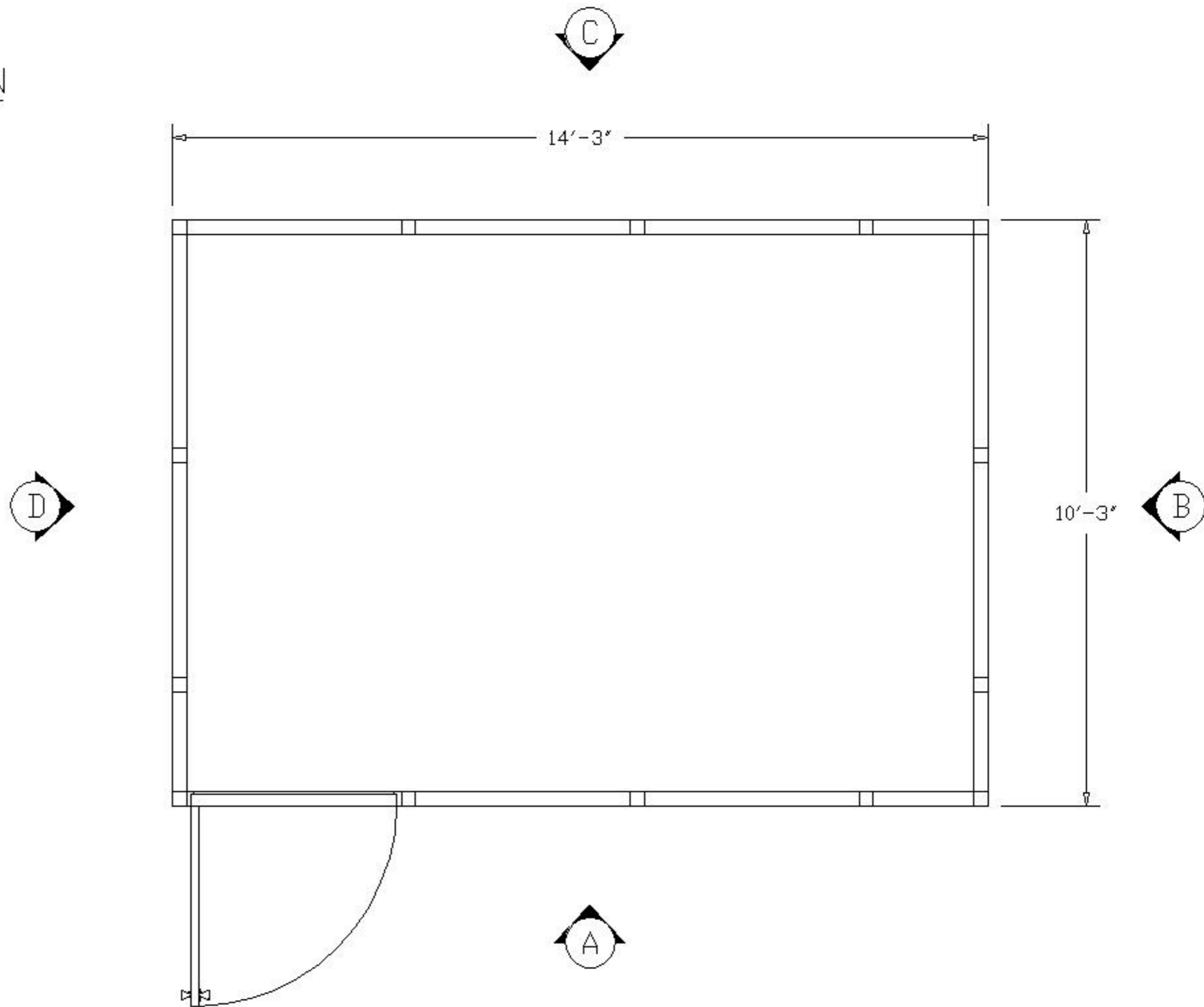

PLEASE MARK DESIRED LOCATION OF OPTIONS
 SHOWN IN LEGEND ON FLOOR PLAN

EX3-10148

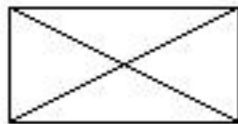
<u>DESCRIPTION</u>	<u>SYMBOL</u>	<u>DESIGNATION</u>
TYP. 2'X4'X5/8" MINERAL BOARD = CEILING TILE		= C/T
TYP. 2' X 4' LAY IN 4 TUBE = LIGHT FIXTURE		= L/F

