

PLEASE MARK DESIRED LOCATION OF OPTIONS  
 SHOWN IN LEGEND ON FLOOR PLAN  
 IP3-STM-12208

<u>DESCRIPTION</u>	<u>SYMBOL</u>	<u>DESIGNATION</u>
208V OUTLET =	⊕	⊕
TYP. EMERGENCY FLOOD LIGHTS =		E/L
120V DUPLEX OUTLET =	⊕	⊕
LIGHT SWITCH =	\$	\$
MAIN PANEL =	PNL	PNL
TYP. 2' X 4' LAY IN 4 TUBE LIGHT FIXTURE =		L/F
THRU WALL HVAC UNIT =	HVAC	HVAC
8" SQ. TUBE STEEL COLUMN =	⊗	

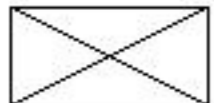

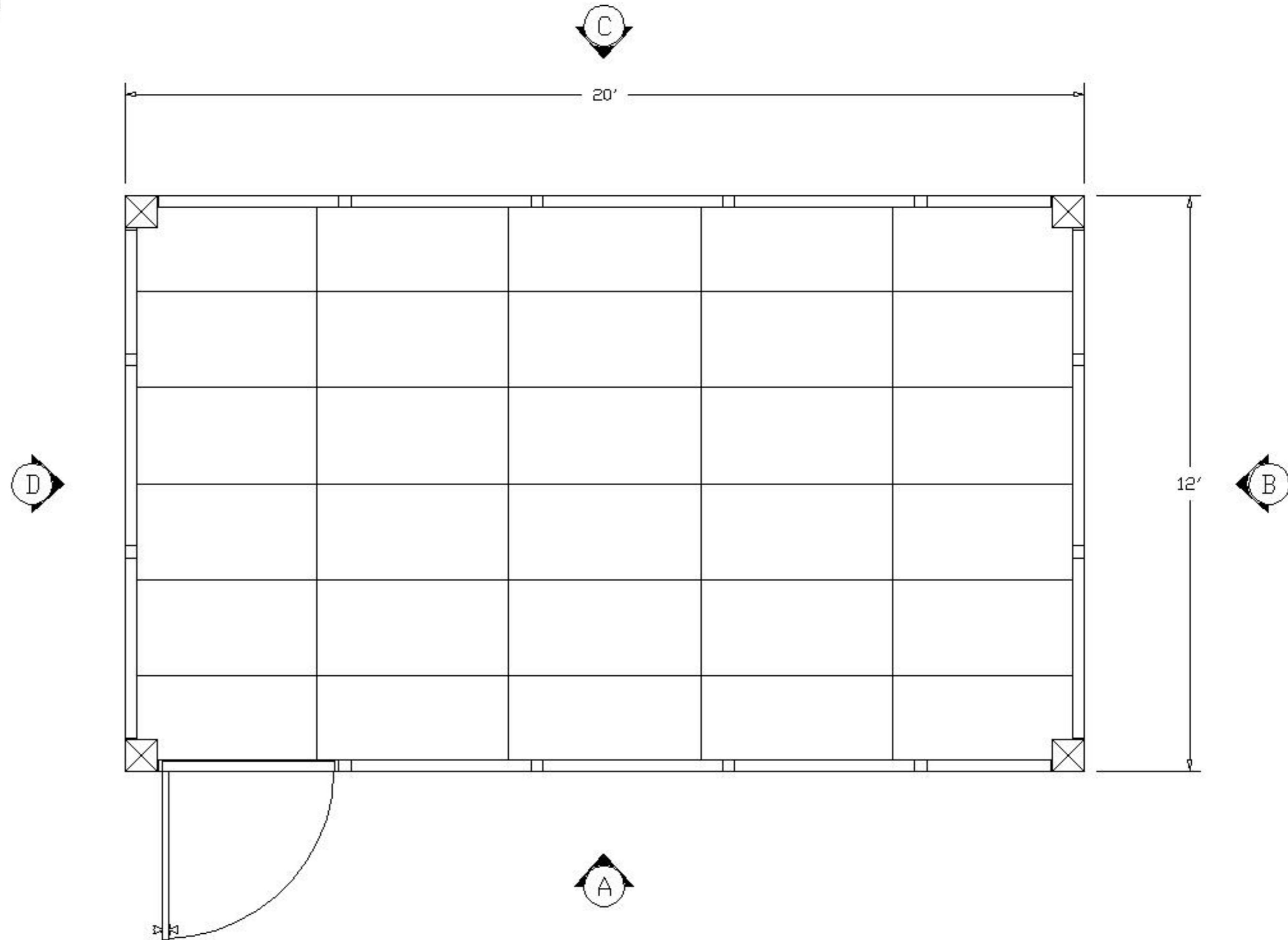
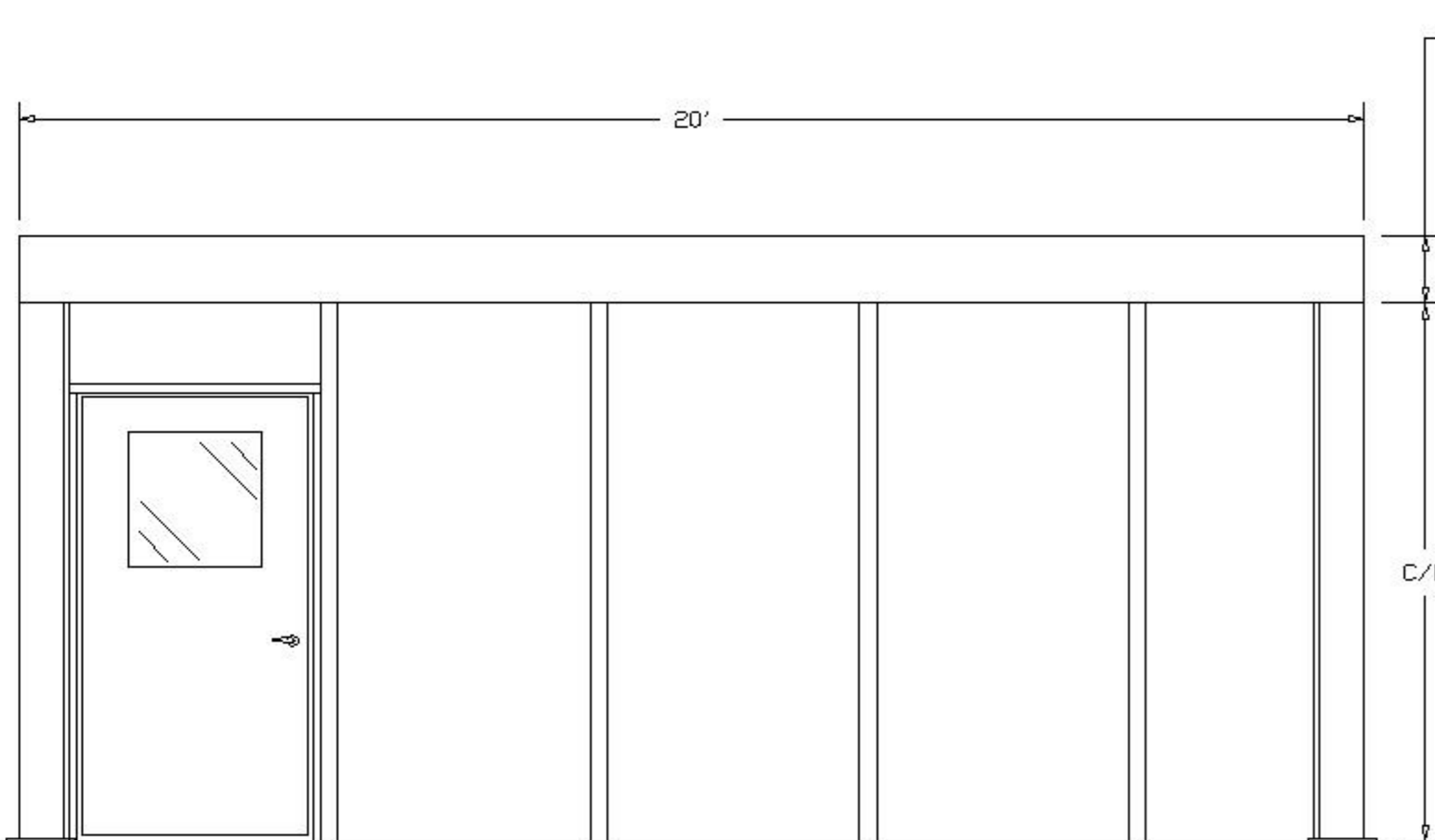

"A" ELEVATION

DIMENSION VARIES UPON SPAN LENGTH AND DECKING OPTIONS

C/H SPECIFY CLEAR HEIGHT (STANDARD IS 8')



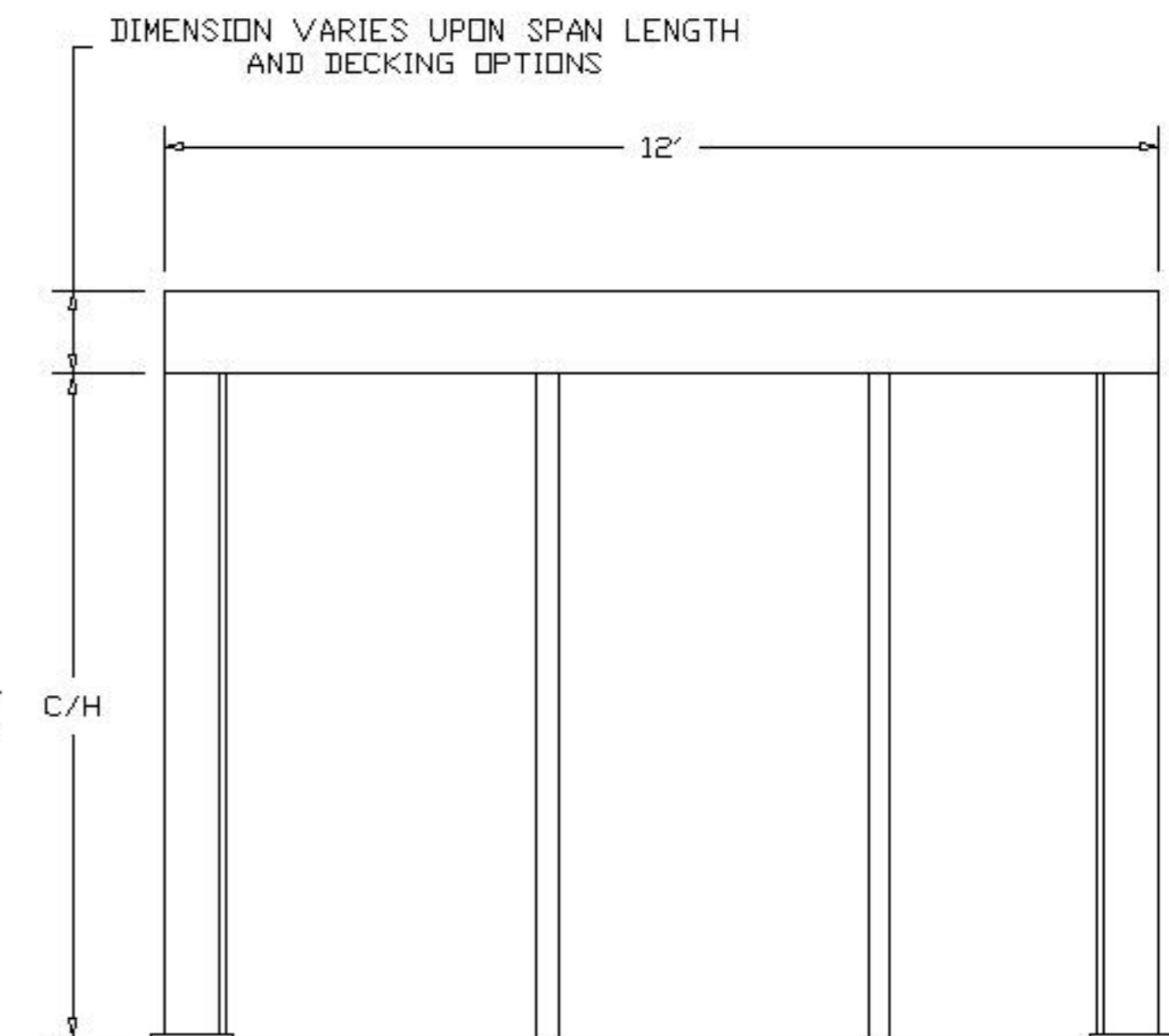

IP3-STM-12208



"B" ELEVATION

DIMENSION VARIES UPON SPAN LENGTH AND DECKING OPTIONS

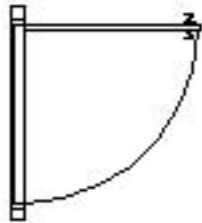
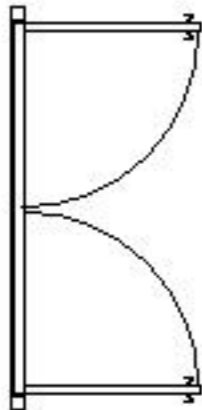
PLEASE MARK DESIRED LOCATION OF OPTIONS  
 SHOWN IN LEGEND ON FLOOR PLAN  
 IP3-STM-12208

<u>DESCRIPTION</u>	<u>SYMBOL</u>	<u>DESIGNATION</u>
WINDOW PANEL =		W/P
SLIDING WINDOW PANEL =		SW/P
SOLID PANEL =		S/P
42" X 80" DOOR W/ 2' X 2' WINDOW =		D/L
DOUBLE DOOR W/ 2' X 2' WINDOW =		DD/L
8" SQ. TUBE STEEL COLUMN =		

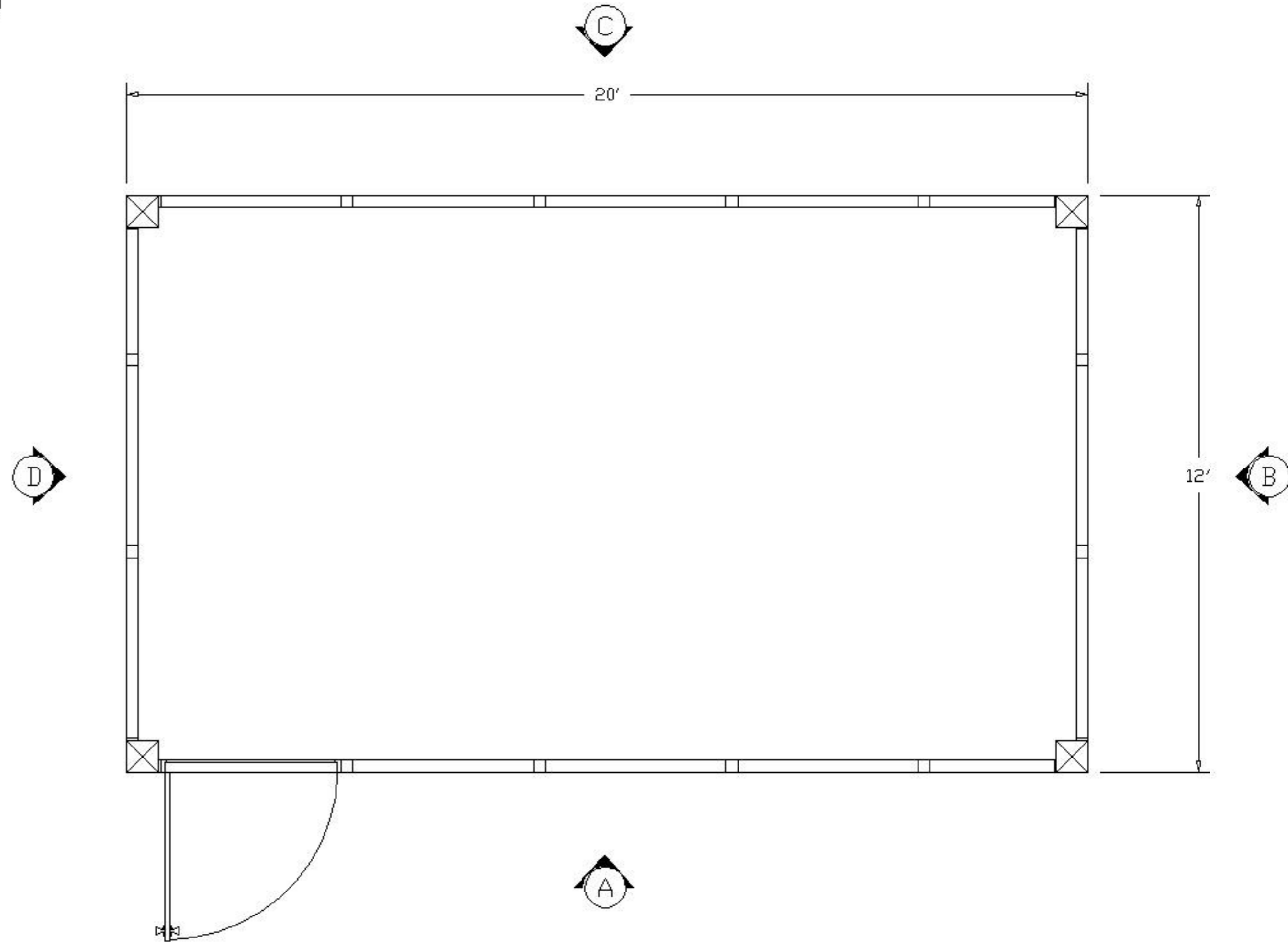

PLEASE MARK DESIRED LOCATION OF OPTIONS  
 SHOWN IN LEGEND ON FLOOR PLAN  
 IP3-STM-12208

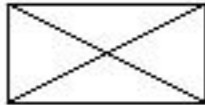
<u>DESCRIPTION</u>	<u>SYMBOL</u>	<u>DESIGNATION</u>
TYP. 2'X4'x5/8" MINERAL BOARD CEILING TILE =		C/T
TYP. 2' X 4' LAY IN 4 TUBE LIGHT FIXTURE =		L/F
8" SQ. TUBE STEEL COLUMN =	